

CREATOR[®]
Audio/Visual Solution Provider & Manufacturer

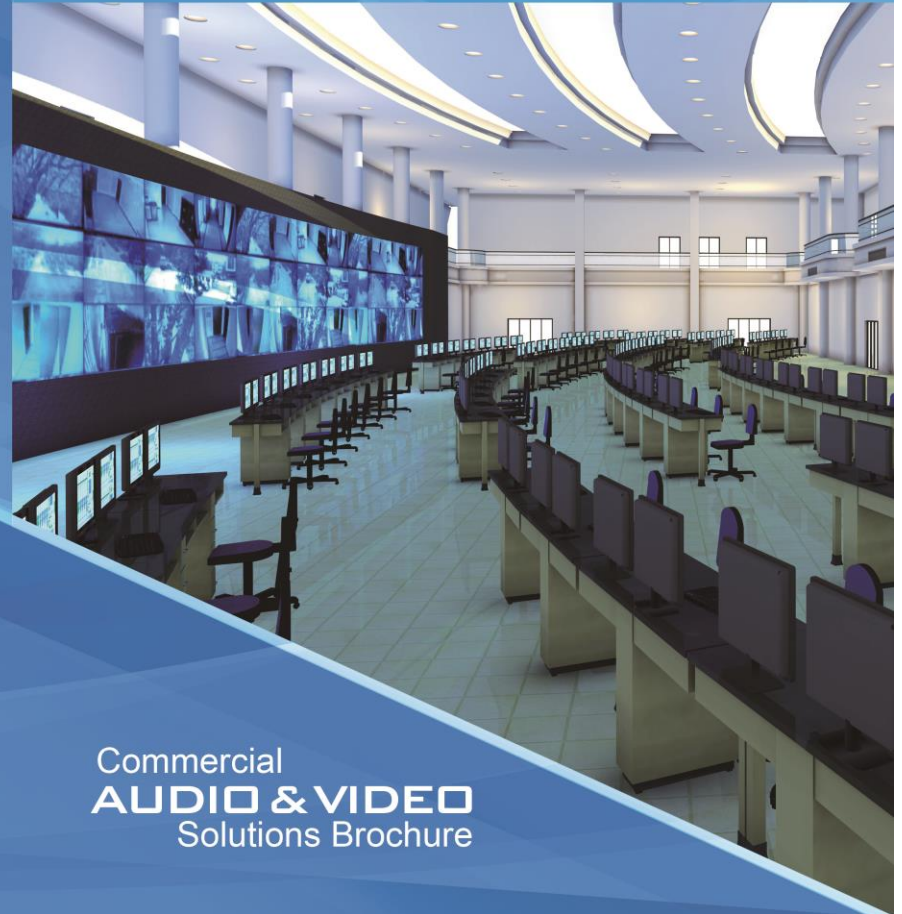

CREATOR[®]

CREATOR CORPORATION (CHINA)

Address: 3/F, Bldg 5, Guangzhou Sciencetech Park, No.9, Lanyu 4th St., KaiFa Avenue,
Economic & Technological Development Zone, Guangzhou, China, 510730

Tel : (+86 20) 8220 8736(Direct)

Fax : (+86 20) 8221 9744

Email: sales@creator.com.cn

Website: www.creator1997.com

Commercial
AUDIO & VIDEO
Solutions Brochure



► Company Profile

CREATOR, founded in 1997, is a professional Audio/Visual products manufacturer and solution provider. It has been specialized in the R&D (Research & Development), manufacturing, and marketing a wide range of top quality Pro A/V products, and now is an internationally renowned brand of the industry.

CREATOR is always committed to exploring the latest technology and advancing in the forefront of Audio/Visual industry. The headquarter of CREATOR is located in Guangzhou which facilitates about 10,000 square meters for R&D Manufacturing Center and Sales Office. To guarantee the excellence and stableness of our products, which ensures our clients' satisfaction, we have established divisions for different departments, such as Material Purchasing, SMT, Molding, Assembling, Quality Control, Package and Service department, etc. Each department has its own responsibility and close connection with each other. To provide competitive solutions and services in all directions, we set integrating with the era of informatization, digitalization, and intellectualization as our mission. After years of endeavor, we have mastered the core technology in Intelligent Conference System, Control System and Signal Management and gained a large amount of intellectual property rights.

To provide the best customer experience possible, CREATOR formed an integrated globally covered service network. In China, we have branches in more than 20 cities, including Beijing, Shanghai, Shenzhen, Shenyang, Chengdu, Shandong, covering the whole China. Abroad, we have set up branches in Singapore, Taiwan, Australia, the United States and Dubai. With a globally covered service network, we provide services for customers all around the world. At the same time, our friendly and knowledgeable support team is always ready for technical support, after-sales services and system design advice.

Depending on virtue of our systematic solutions of high standard, CREATOR has accomplished countless breakthroughs and achievements one after another in the past decades. For instance, in China, we dedicated to Beijing Olympic Games, Guangzhou Asian Paralympic Games and China-Eurasia Expo. In international cases, our products showed up in the AU Summit, the UN General Assembly, FIESP, Rio De Janeiro Olympic Games and other projects.

Looking forward to the future, CREATOR will continue focusing on innovation and development in Pro A/V industry, strive to become a world leading brand.

► Development History

- 1997 CREATOR CORPORATION (CHINA) was established.
- 1998 We developed China's first programmable central control unit and successfully entered into the market.
- 2000 CREATOR R&D center was set up, commitment to new product development.
- 2001 CREATOR products were widely used in the electricity, telecommunications, transportations, government, public security, military, sports, medical and other fields.
- 2003 We introduced the SMT production equipment from world-renowned FUJI and set up the SMT processing center.
- 2004 CREATOR launched the matrix system and conference system.
- 2005 We expanded our plant and our R&D center occupies 2,000 square meters.
- 2006 We set up a mold factory and developed the world's first touch screen video PIP.
- 2007 CREATOR speeded up exploring overseas market and successfully established branches in Singapore, the United States and Australia.
- 2009 CREATOR entered the field of LED display.
- 2010 We created the first set of LED multi-screen visualized network control platform in China.
- 2011 Our Shenzhen Branch was established.
- 2012 CREATOR launched the world's first 5G WIFI conference system.
- 2013 We launched the "CM" modular HD transmission and switching systems, established branches in Shandong and Chengdu.
- 2014 We launched PRO-MAX Series Matrix Switchers.
- 2016 Distributed matrix was launched, which integrated the functions of matrix, mosaic, control, KVM and transmission.

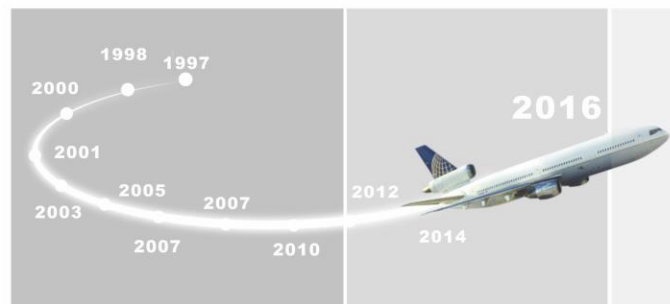



PRO-MAX

series matrix switchers

The PRO-MAX series splicing matrix switchers are seamless matrix switchers with very flexible configuration options. They have adopted high performance hardware design, perfectly support various kinds of high definition digital/analog signals switching and processing. Bi-directional RS-232, bi-directional IR signals distribution and switching are also supported. They can also splice the signal for one complete image into multiple signals and then distribute them to different display units, which provide a one-stop solution for the video and control signals distribution and switching in various industries, especially for broadcasting and television projects, multimedia meeting rooms, big display projects, TV education, smart traffic management centers and command center.



PRO-MAX | This control slot frame contains items:
PRO-MAX0808161636367272144144285288

PRO-MAX Series Card Type

Input Card	PMAX-IN HDMI4, PMAX-IN DV14, PMAX-IN HD4, PMAX-IN VGA4, PMAX-IN SDI4, PMAX-IN SF4, PMAX-IN IP4, PMAX-IN DU-DV12, PMAX-IN CVBS16
Output Card	Seamless Output: PMAX-OUT HDMI4, PMAX-OUT DV14, PMAX-OUT HD4, PMAX-OUT VGA4, PMAX-OUT SDI4, PMAX-OUT IP4, PMAX-OUT UHD-HDMI2 Splicing Output: PJMAX-OUT HD4, PJMAX-OUT DV14, PJMAX-OUT DV12, PJMAX-OUT HD2, PJMAX-OUT SF4
Others	PMAX-PR LINK, PMAX-Con ETN4, PMAX-Con ETN5



CR-iMAX901HD-A

scaler switcher

CR-iMAX901HD-A is a scaler which has 9 video input interfaces, including CV, YPbPr, VGA, DisplayPort, HDMI, HDBaseT, which can be switched or scaled to HDMI/HDBaseT output. The output resolution can be defined by user up to WUXGA(1920 x1200). It's a high performance scaler for education institution, conference room, demonstration hall, command center etc.

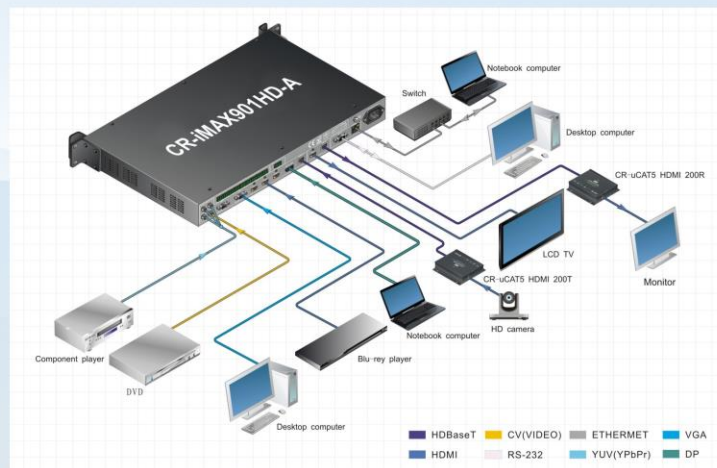



Converters

CREATOR Converters consists of two series, which are HDBaseT CAT5 series and Fiber series. HDBaseT CAT5 series can convert a HD 1080P video to a distance of 100M. Fiber series can reach a distance up to 300M through the multi-mode optical fiber cable or reach a distance up to 20KM with the single-mode optical fiber cable. These converters can be a supplement of matrix or work reliably without any programming or configuration. They can convert to CV, YPbPr, VGA, DVI, HDMI video and audio signal. Besides, they also support RS-232 to pass through devices such as USB mouse and keyboard signals.



CR-uEC COMP 300T/R
ANY series COMP transmitter



CR-uCAT5 COMP 300T/R
HDBaseT series COMPONENT/
CAT5 transmitter



CR-uCAT5 HDMI 4KT/R
HDMI transmitter



CR-uSF AV 200T/R
COMPONENT transmitter



CR-uSF HD 200T
HD transmitter



CR-uSF DVI 200R
DVI/FIBER receiver



Digital Conference System

Digital conference system is a cost-effective intelligent wired conference system. Through controlling the front panel keys and the software, it can realize the centralized control of all the conference functions. The conference controller can connect 128 conference units on its own, while through the expansion controller, it can connect 1000 units at most. Besides speaking units, this system can also connect 36 sets of translation units and realize simultaneous interpretation function of 11+1 kinds of language.

CR-M4101
Conference system controller



CR-M4202/04A2
Tabletop discussion & voting unit



CR-M4102/04B
Tabletop discussion unit





Full Digital Conference System

Full Digital Conference System is an improvement and updated version of Digital Conference System. It sets simultaneous interpretation, voting, microphone management, display unit, camera tracking, tea application into one. Cat5e and 100M network transmission for full digital audio and control signal, so that no influence to sound quality during long distance transmission. Combined with the 32 bit high speed floating point and DSP processing technology, the Full Digital Conference System can be applied in regular enterprise meetings, school meetings, government conferences, command center and large-scale international conferences.

CR-DIGS201-A
Conference system controller



CR-DIG5202/04B2
Discussion & voting unit with VFD nameplate



CR-CAT5202/04C1, CR-CAT5202/04C2
Flush mounted CAT5 discussion unit



CR-DIG5204E2
Tabletop discussion unit



Full Digital Wireless System

Full Digital Wireless System is a high-tech conference system of the new generation. It supports both wired conference and wireless conference through WiFi. The encryption function of WPA/WPA2 wireless security technology ensures the conference confidentiality and avoid wiretapping and malicious interference. Besides, the built-in high performance CPU sets high-speed translation, simultaneous interpretation, camera tracking, discussion, attendance, voting, electronic nameplate as a whole. It is suitable for all kinds of meetings and conferences for its unprecedented high efficiency, flexibility, security and compatibility.

CR-WiFi6301
Encryption WiFi conference controller



CR-WiFi6302/04B
Encryption WiFi conference discussion unit



CR-WF30A
Access point



CR-WFDS06
WiFi charging box



IR Wireless Interpretation System

Creator IR Wireless Interpretation System is a clear, flexible and stable interpretation system. It adopts the digital DQPSK modulation and high-speed DSP processing technology. 30 sets of high performance infrared radiation panels can be connected simultaneously and its transmitting distance can reach 76 meters. Plus, this system is light, handy and portable because it is combined by many small parts. To sum up, IR Wireless Interpretation System is your best choice for any simultaneous interpretation projects.

CR-IR3000A
16 channels digital
infrared transmitting controller



CR-IR3001
High performance infrared radiation panel



CR-IR3002A
8/16 channels infrared receiver



CR-DS40A
The infrared receiving unit charging box



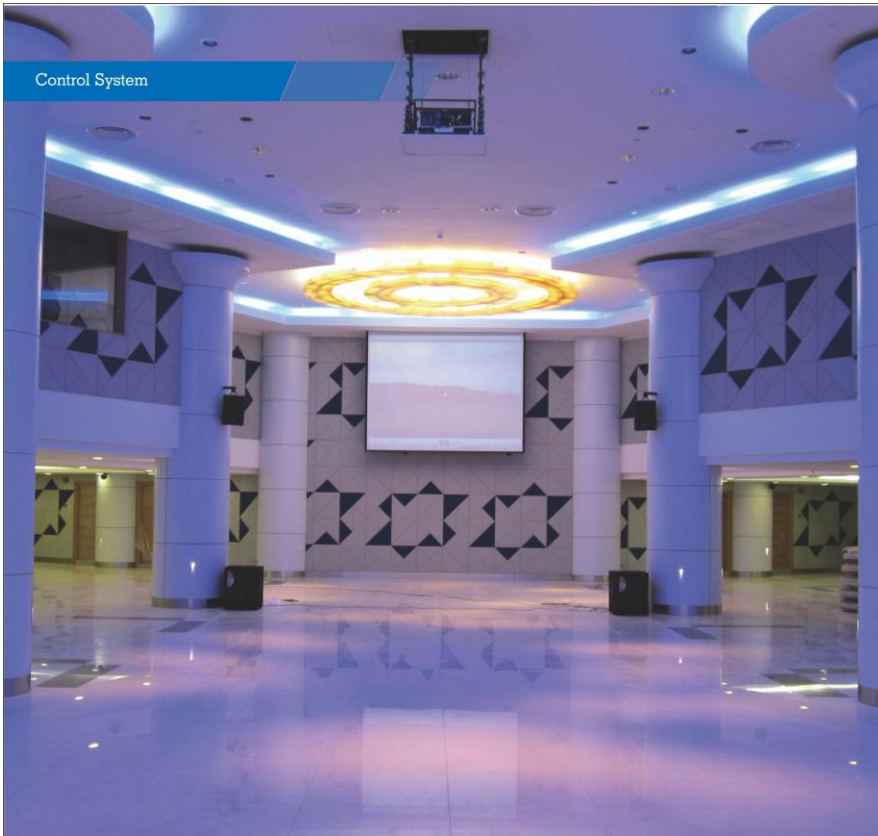

Control System

CR-PGM III, a network communication controller, is the breakthrough achievement of CREATOR's independent research and development. The frequency of 32 bit embedded processor is up to 667MHZ, with ARM 11 CPU, 256M ram and 1G memory. There are various interfaces in CR-PGM III: 8 independent programmable infrared transmission interfaces; 8 independent programmable RS-232/422/485 control interfaces; 8 weak relay interfaces; 8 digital input/output IO interfaces; 3 kinds of network communication: CR-LINK, CR-NET, Ethernet; USB2.0 programmable interface. Matched with the programmable touch screens, no matter at home, in conference rooms and control center, this Network Programmable Control system is second-to-none in your project.



CR-PGMIII
High performance network
programmable controller



CR-WiFi G7S
8 inch handheld wireless programmable
touch screen



CR-POWER8IV
Power supply controller



CR-VOLIII
Volume controller

Solution for Normal Conference Room

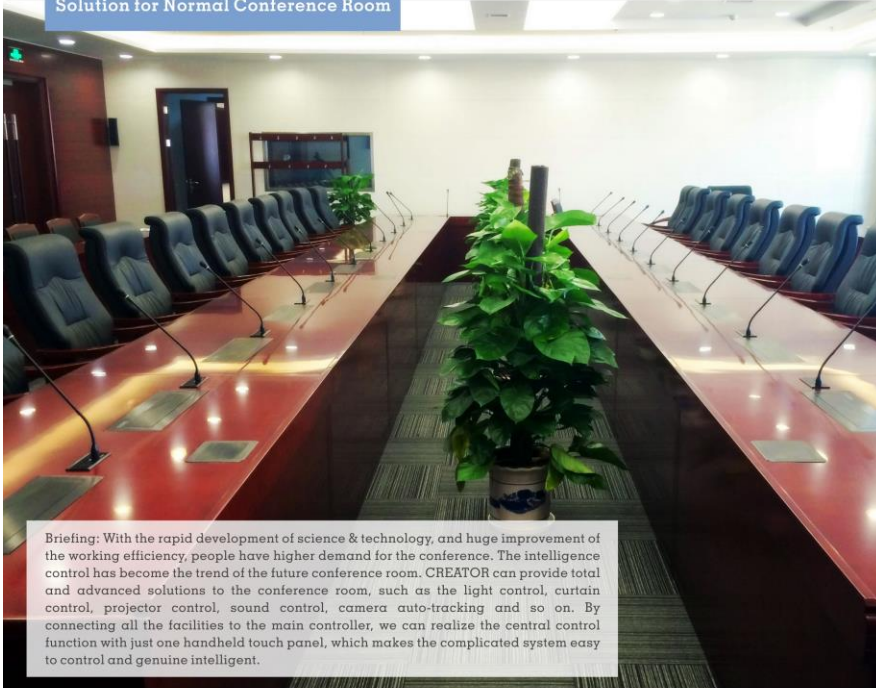

Briefing: With the rapid development of science & technology, and huge improvement of the working efficiency, people have higher demand for the conference. The intelligence control has become the trend of the future conference room. CREATOR can provide total and advanced solutions to the conference room, such as the light control, curtain control, projector control, sound control, camera auto-tracking and so on. By connecting all the facilities to the main controller, we can realize the central control function with just one handheld touch panel, which makes the complicated system easy to control and genuine intelligent.

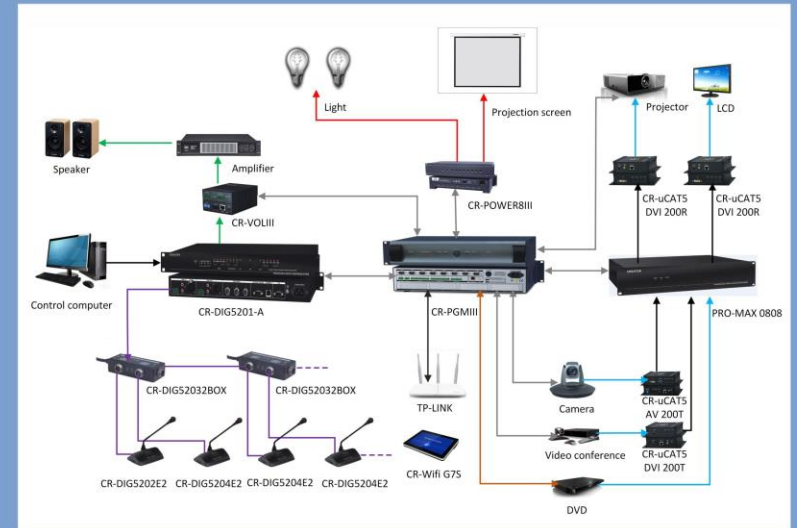

System Connecting Diagram

Solution for WiFi Conference Room

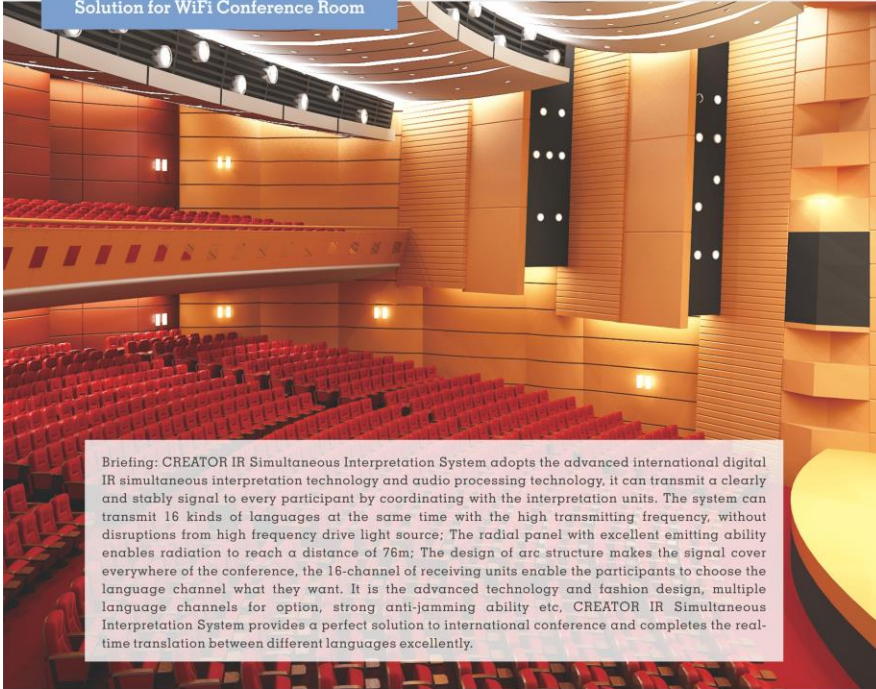

Briefing: CREATOR IR Simultaneous Interpretation System adopts the advanced international digital IR simultaneous interpretation technology and audio processing technology, it can transmit a clearly and stably signal to every participant by coordinating with the interpretation units. The system can transmit 16 kinds of languages at the same time with the high transmitting frequency, without disruptions from high frequency drive light source; The radial panel with excellent emitting ability enables radiation to reach a distance of 76m; The design of arc structure makes the signal cover everywhere of the conference, the 16-channel of receiving units enable the participants to choose the language channel what they want. It is the advanced technology and fashion design, multiple language channels for option, strong anti-jamming ability etc. CREATOR IR Simultaneous Interpretation System provides a perfect solution to international conference and completes the real-time translation between different languages excellently.

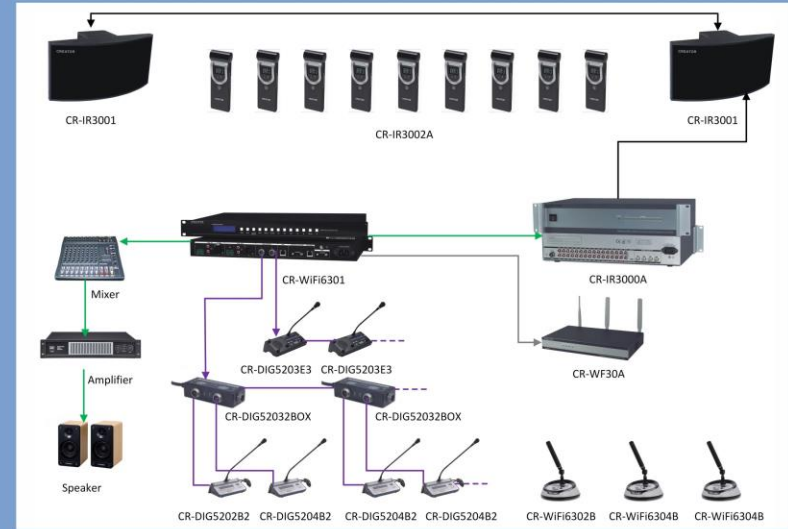

System Connecting Diagram

Solution for the Restaurant



Briefing: A top level restaurant provides not only the delicious food but also an elegant and comfortable dining environment. With the CREATOR Central Control System, the restaurant can control the audio & video system, music, lightness, temperature, humidity etc in real-time perfectly. All of these will bring the customers graceful and comfortable experiences.

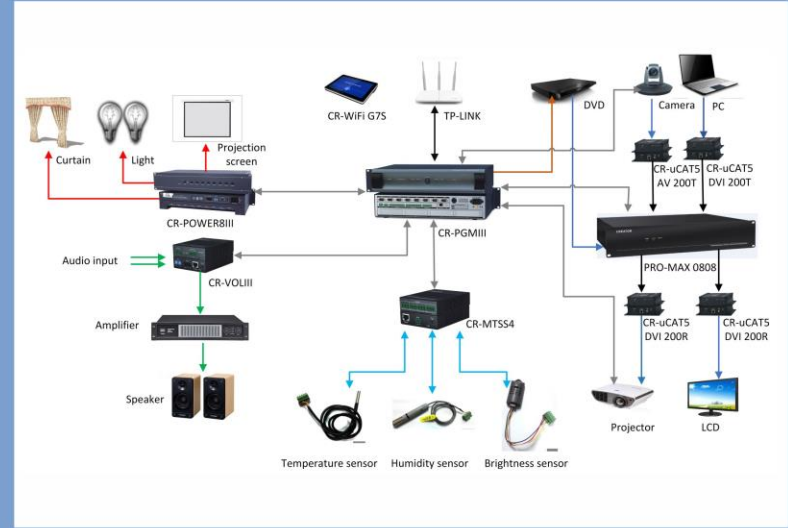

System Connecting Diagram

Solution for Command Center

Briefing: CREATOR PRO MAX graphic image management platform helps the small and medium command centers to realize modular and digital in commanding. It saves a lot of cost on human & material resource and operation, it also improves the efficiency of video analysis and plays an important role in command center by realizing highly centralize analysis, comparing and visualizing management of different data. PRO MAX graphic image management platform can meet the requirements of switching and transmitting various signals. In addition, each seamless output card can realize the real-time seamless switching, accomplish a lot of advanced functions such as the splicing, splitting & previewing the screens, opening, roaming and overlapping the windows, KVM and so on. Working with CREATOR Central Control System can realize the management in one touch panel and improve the work efficiency rapidly.

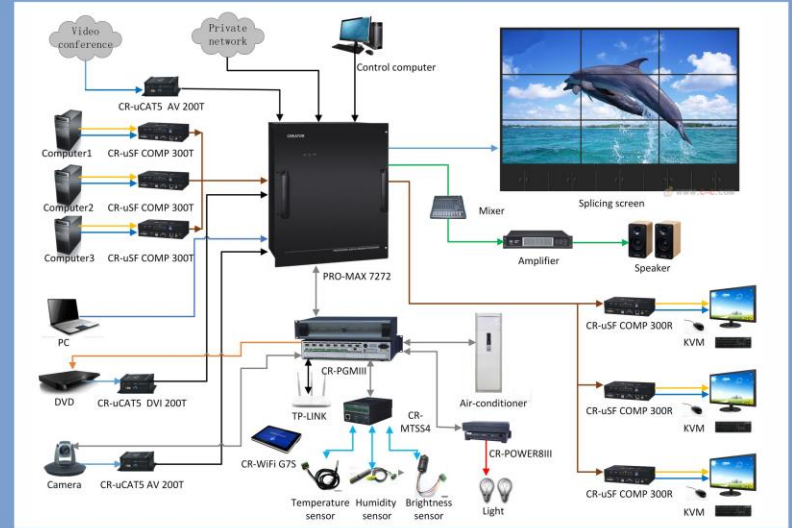
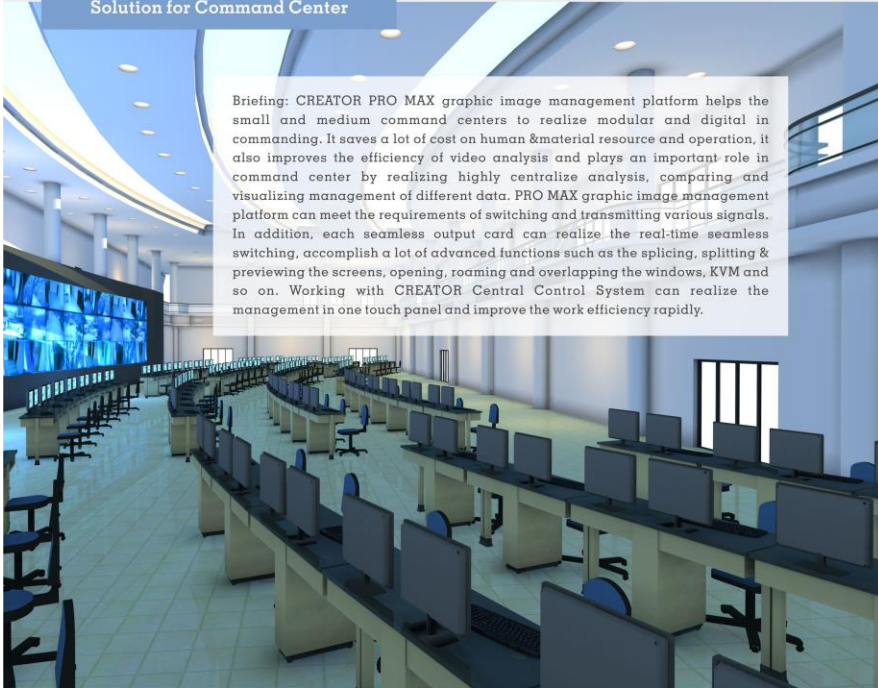

System Connecting Diagram

Solution for HD Wireless Image Sharing System



Diagram1:



Diagram2:



System Connecting Diagram



► Brazil Solomon's Temple

In early August, 2014 of Brazil, there was a grand ceremony held in Solomon's Temple for its completion. The ceremony was attended by President Dilma Rousseff and her predecessor, Luis Inacio Lula da Silva, among many other influential political figures from Sao Paulo and throughout Brazil. The church was equipped with 1000 sets of CREATOR interpretation equipments to achieve the realtime multilingual communication.



◀ Malacca State Building Conference Room



Malacca state building intelligent conference room solution used the CREATOR Full Digital Conference System products, including conference controller: CR-DIGS201, hidden-mic LCD discussion voting unit: CR-DIGS202/04A2. Control system is a network programmable controller: CR-PGMIII, matched with an 8 inch handheld wireless programmable touch screen: CR-WiFi WG7pip. These two systems truly made conference simple and convenient, what's more, this conference system was perfectly matched the conference room decorating style.



► Mandarin Oriental Hotel Taipei

After a long period of planning and engineering, the hotel project was completed in this year. The president suite and executive suite used CREATOR network programmable controller: CR-PGMIII to control image/sound/light/air condition/circumstance/butler service. We supplied two sets CREATOR 8" wireless touch screen: CR-WiFi WG7pip, in each room for user to use.